





NEOSTAR

3P+54 Dual-Glass Module

465W-495W

Technical Features:

-  Partial Shading Optimisation
-  Better Temperature Coefficient
-  High Temperature Restriction
-  Micro-crack Resistance
-  Higher Power
-  Lower BOS
-  More Aesthetic Values
-  Infinite Technology



red dot winner 2023



Product Warranty
Extendable to 25years*



Performance Warranty



Warranty partner

Munich RE 

495W
Output

24.8%
Efficiency

≤1%
First-year Degradation

≤0.35%
Annual Degradation from Year 2-30

30-year Linear Performance Warranty

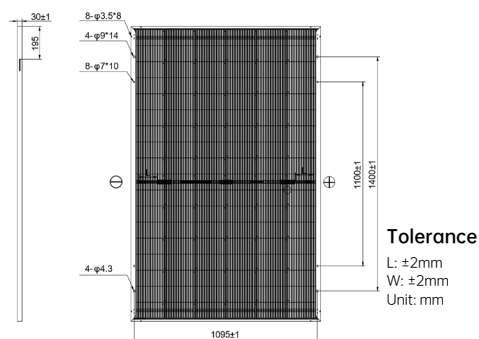
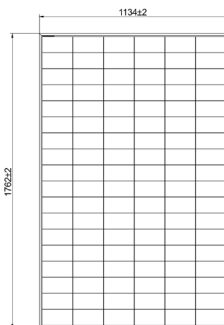
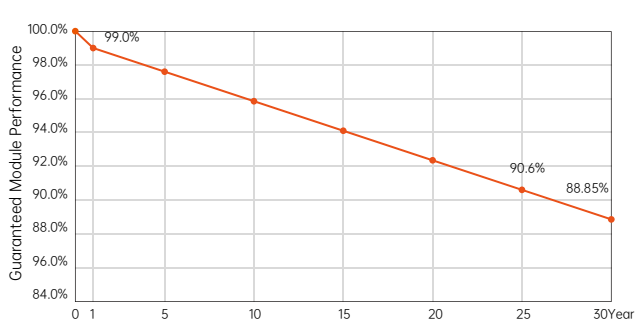

Electrical Characteristics (STC: AM1.5 1000W/m² 25°C NOCT: AM1.5 800W/m² 20°C 1m/s)

Power Tolerance: 0~ + 3%

Module Type	AIKO-A465-MCE54Dw	AIKO-A470-MCE54Dw	AIKO-A475-MCE54Dw	AIKO-A480-MCE54Dw	AIKO-A485-MCE54Dw	AIKO-A490-MCE54Dw	AIKO-A495-MCE54Dw
Test Conditions	STC	NOCT	STC	NOCT	STC	NOCT	STC
P _{max} [W]	465	352	470	356	475	360	480
V _{oc} [V]	40.60	38.52	40.70	38.61	40.80	38.71	40.90
V _{mp} [V]	34.20	32.45	34.30	32.54	34.40	32.64	34.50
I _{sc} [A]	14.69	11.87	14.72	11.89	14.76	11.93	14.80
I _{mp} [A]	13.60	10.87	13.71	10.96	13.81	11.04	13.92
Module Efficiency	23.3%	23.5%	23.8%	24.0%	24.3%	24.5%	24.8%

Product Specification

Cell Type	N-Type ABC
Glass	Dual glass, 2.0 + 2.0mm coated semi tempered glass
Frame	Black anodized aluminum
Cable	4mm ² (IEC) 12AWG(UL) ±1200mm
No. of Cells	108(6*18)
Junction Box	IP68, 3 bypass diodes
Connector	Original MC4
Weight	24.2kg±3%
Dimension	1762*1134*30mm
Package Detail	37pcs per pallet / 222pcs per 20'GP / 962pcs per 40'HC

Temperature Ratings (STC)

Temperature Coefficient of I _{sc}	+ 0.05%/ °C
Temperature Coefficient of V _{oc}	- 0.22%/ °C
Temperature Coefficient of P _{max}	- 0.26%/ °C

Installation Guide

Operation Temperature	-40°C - +85°C
Maximum Series Fuse Rating	30A
Protection Class	Class II
Maximum System Voltage	DC1500V
Maximum Static Loading	Front 5400Pa Back 2400Pa
Hail Test	25 mm diameter hail at 23 m/s
Fire Rating	IEC Class A

